

LHS CONNECTOR SERIES

Rack & Panel Blind Mating Modular Connectors NF 61-032

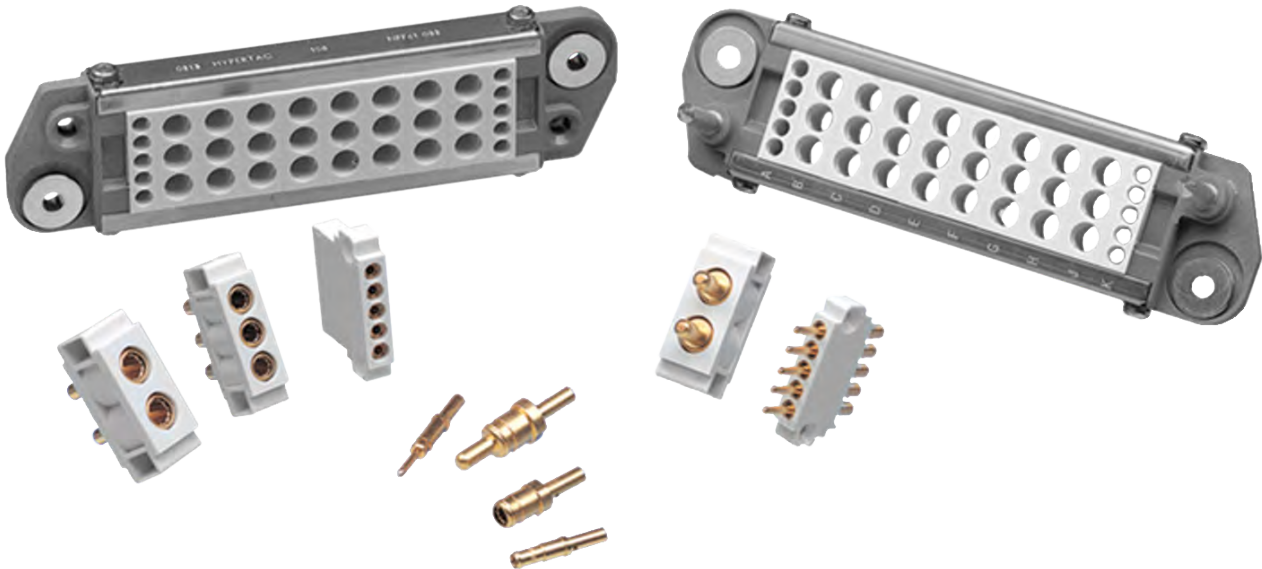

HYPERBOLOID TECHNOLOGY

Smiths Connectors offers an extensive range of superior contact technologies suitable for standard and custom solutions. Hypertac® (HYPERboloid conTACT) is the original superior performing hyperboloid contact technology designed for use in all applications and in harsh and demanding environments where high reliability and safety are critical. The inherent electrical and mechanical characteristics of the Hypertac hyperboloid contact ensures unrivalled performance in terms of reliability, number of mating cycles, low contact force and minimal contact resistance. The shape of the contact sleeve is formed by hyperbolically arranged contact wires, which align themselves elastically as contact lines around the pin, providing a number of linear contact paths.

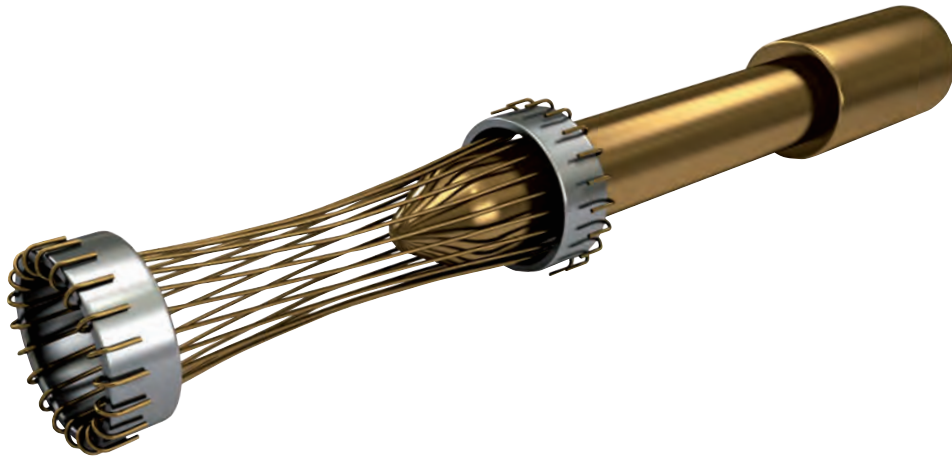

FEATURE

LOW INSERTION/EXTRACTION FORCES

The angle of the socket wires allows tight control of the pin insertion and extraction forces. The spring wires are smoothly deflected to make line contact with the pin.

LONG CONTACT LIFE

The smooth and light wiping action minimizes wear on the contact surfaces. Contacts perform up to 100,000 insertion/extraction cycles with minimal degradation in performance.

LOWER CONTACT RESISTANCE

The design provides a far greater contact area and the wiping action of the wires insures a clean and polished contact surface. Our contact technology has about half the resistance of conventional contact designs.

HIGHER CURRENT RATINGS

The design parameters of the contact (e.g., the number, diameter and angle of the wires) may be modified for any requirement. The number of wires can be increased so the contact area is distributed over a larger surface. Thus, the high current carried by each wire because of its intimate line contact, can be multiplied many times.

IMMUNITY TO SHOCK & VIBRATION

The low mass and resultant low inertia of the wires enable them to follow the most abrupt or extreme excursions of the pin without loss of contact. The contact area extends 360° around the pin and is uniform over its entire length. The 3 dimensional symmetry of the Hypertac contact design guarantees electrical continuity in all circumstances.

BENEFIT

HIGH DENSITY INTERCONNECT SYSTEMS

Significant reductions in size and weight of sub-system designs. No additional hardware is required to overcome mating and un-mating forces.

LOW COST OF OWNERSHIP

The Hypertac contact technology will surpass most product requirements, thus eliminating the burden and cost of having to replace the connector or the entire subsystem.

LOW POWER CONSUMPTION

The lower contact resistance of our technology results in a lower voltage drop across the connector reducing the power consumption and heat generation within the system.

MAXIMUM CONTACT PERFORMANCE

The lower contact resistance of the Hypertac contact reduces heat build-up; therefore Hypertac contacts are able to handle far greater current in smaller contact assemblies without the detrimental effects of high temperature.

RELIABILITY UNDER HARSH ENVIRONMENTS

Harsh environmental conditions require connectors that will sustain their electrical integrity even under the most demanding conditions such as shock and vibration. The Hypertac contact provides unmatched stability in demanding environments when failure is not an option.

TABLE OF CONTENTS

LHS SERIES

- ▶ Technical characteristics 2
- ▶ How to order 3
- ▶ Plug & Receptacle dimensions 4
- ▶ Mounting example 5
- ▶ Contacts 6
- ▶ Modules 8
- ▶ Layouts 10
- ▶ Panel cut out 13
- ▶ Tools 14

- ▶ Specific arrangement with High Speed Quadrax Contacts 16

TECHNICAL CHARACTERISTICS

MATERIALS & PLATINGS		ENVIRONMENTAL	
Frame	Inox Soft Steel (Nickel coated)	Temperature range	- 40 °C to 100 °C
Side flange	Polycarbonate	Fire classification	Exigence 2 following NF F 16-102
Insulator	Polycarbonate	Salt spray test	96 hours
Pin & Socket body	Brass, Au/Ni	Acid withstanding	Following NF F 61-032 par. 11.4.6
Socket wires	Copper alloy, Au/Ni	Vibration Withstanding	5 g /25 to 250 Hz
Floating eyelets	Brass (Ni plated)	Insulator mechanical resistance	1000 N
		Max torque for auto threading screws	75 Ncm

ELECTRICAL			
Contact Ø	1.50	2.50	3.50
Creepage distance	1.85 mm	2.25 mm	4.05 mm
Clearance distance	1.25 mm	3.40 mm	5.40 mm
Working current	8 A	16 A	25 A
Insulation resistance		≥ 5.10 ³ MΩ	
Contact resistance	≤ 2.50 mΩ	≤ 1.00 mΩ	≤ 0.80 mΩ
Dielectric withstanding voltage	1500 Vrms	2000 Vrms	3000 Vrms
Voltage rating	110 V	220 V	220 V
Contact holding back in the module	40 N	50 N	70 N
Max male contact mass	1.10 g	2.90 g	4.90 g
Max female contact mass	0.70 g	1.60 g	2.70 g
IF/SF* (max value)	1.60 N	9.00 N	10.00 N

* IF/SF: Insertion and separation force according to NF F 61-032

HOW TO ORDER



1 ▶ SERIES

2 ▶ MODEL

3 ▶ MARKED FRAME*

S

4 ▶ LAYOUT (*consult the factory*)

Layouts included L/RH

NORMALIZED 102 104 108 120 130 147

OTHER 101 TO 1 - -

Layouts included L/ZH

NORMALIZED 302 320

OTHER 301 TO 3 - -

5 ▶ PART - POLARITY

01 PLUG DELIVERED WITHOUT CONTACT (EXCEPT COAXIAL CONTACTS)

02 RECEPTACLE DELIVERED WITHOUT CONTACT

6 ▶ TERMINATION STYLES

00 WITHOUT SIGNAL CONTACT (AND WITH SOLDER COAXIAL) 20 WITHOUT SIGNAL CONTACT (AND CRIMP COAXIAL)

7 ▶ PITCH NUMBER

14

* Only normalized layouts are marked with NF N 61-032

Note: Signal contacts must be ordered separately (see page 6 and 7 for part number)

► PLUG & RECEPTACLE DIMENSIONS

RECEPTACLE

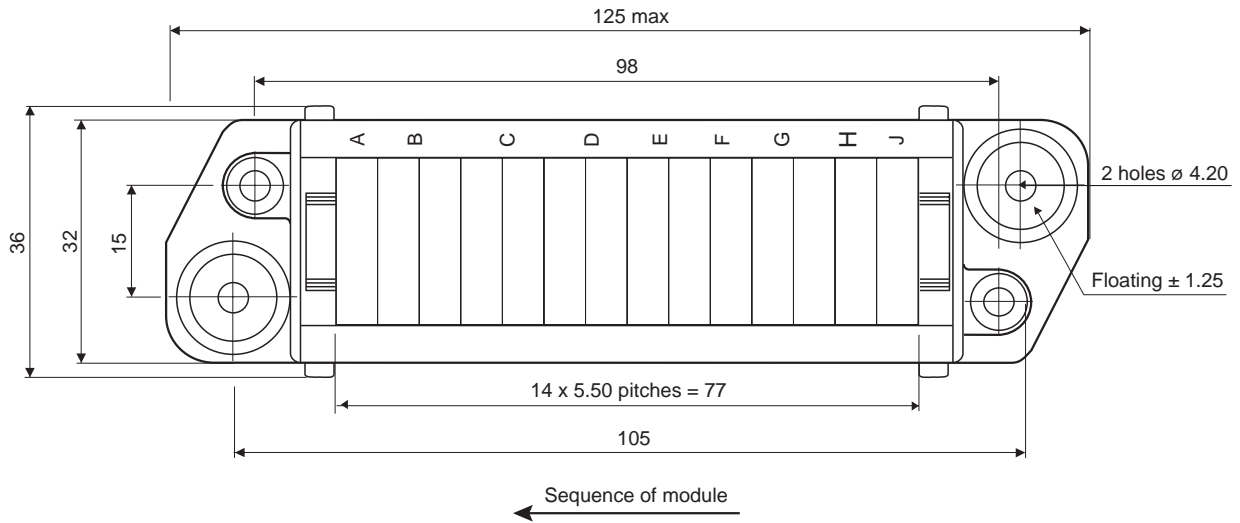

PLUG

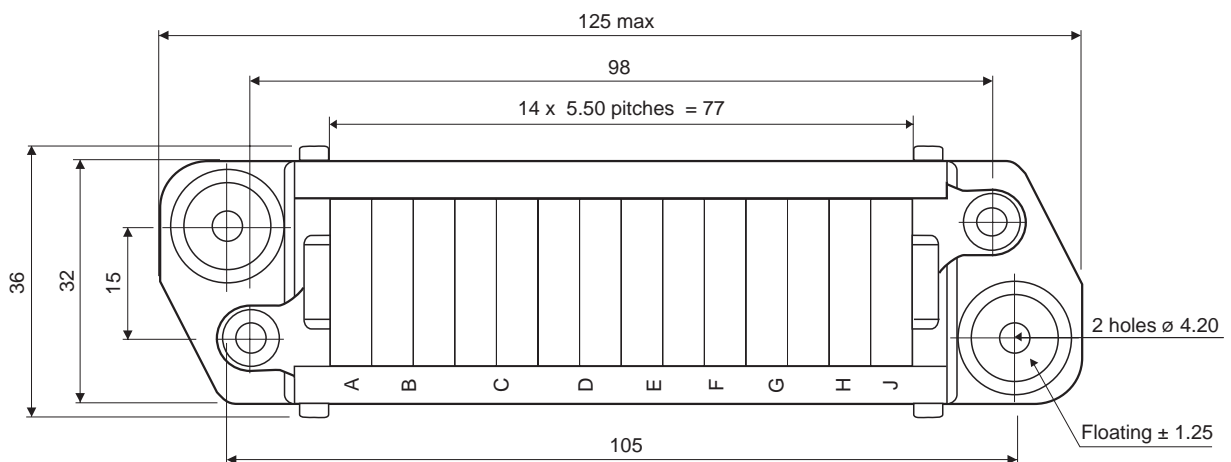
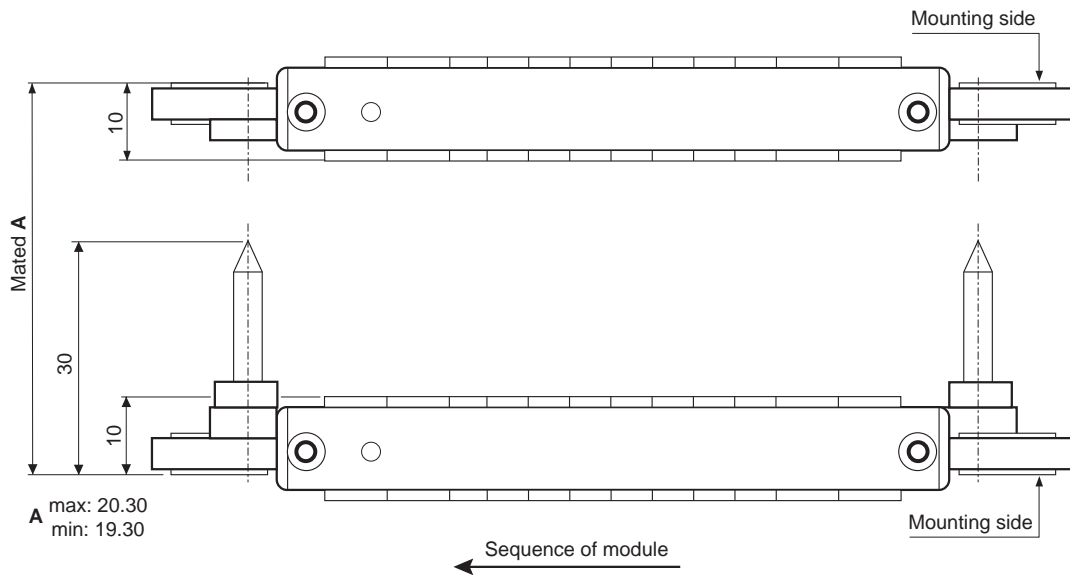

► MOUNTING EXAMPLE WITH L/RHA, L/SH, L/UH MODULES

RECEPTACLE CABLING SIDE VIEW

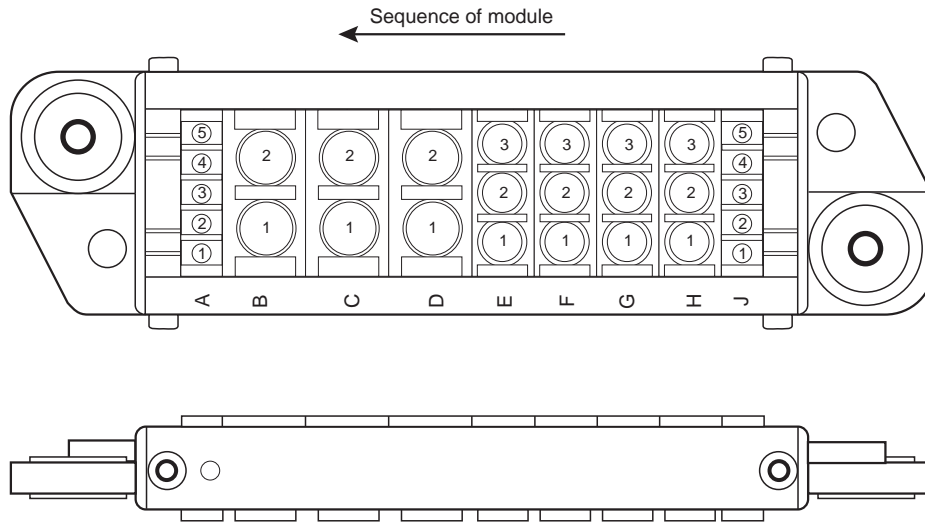

PLUG CABLING SIDE VIEW

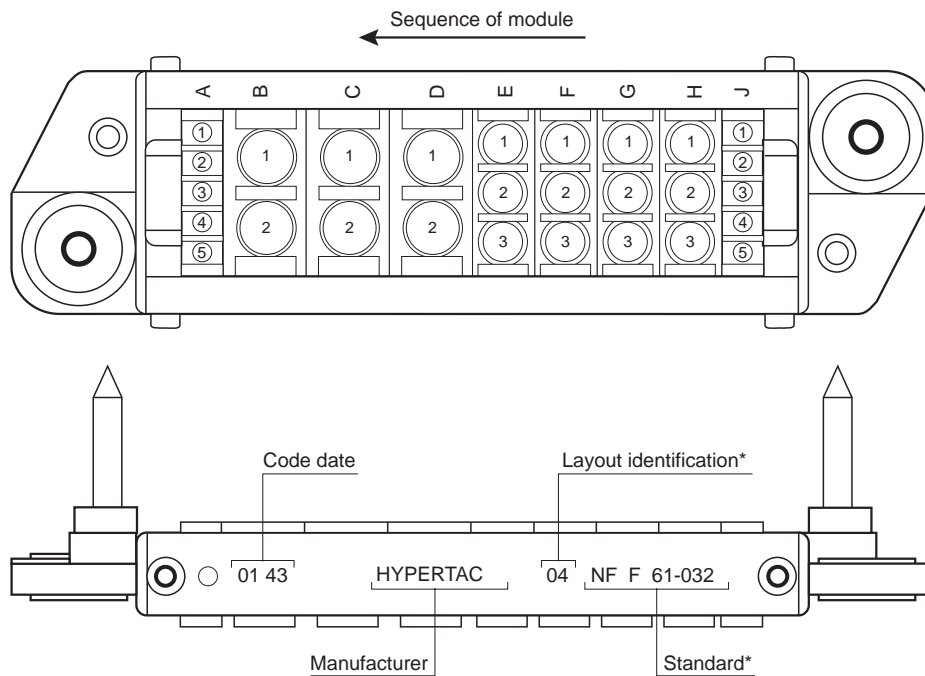

CONTACTS - CRIMP TERMINATIONS

MALE

FEMALE

Ø 1.50 CONTACTS AWG 26-24-22-20-18-16-14

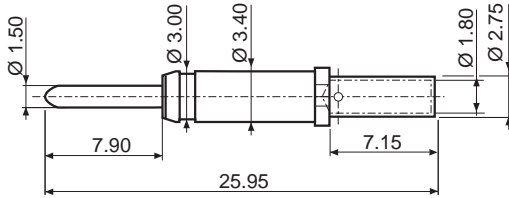

Ref: 015 076 1- 20- OG

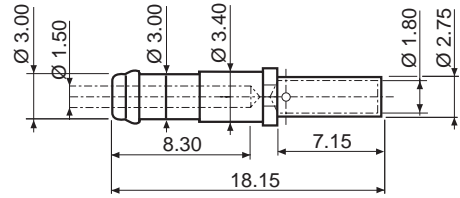

Ref: 015 068 2- 20- G1

Ø 2.50 CONTACTS

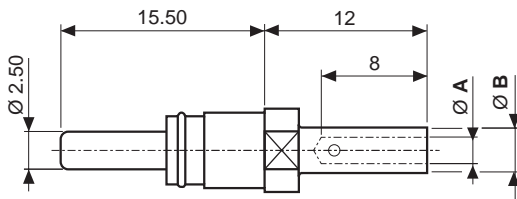

Ref: 025 018 1- 22- OG
Ref: 025 020 1- 23- OG

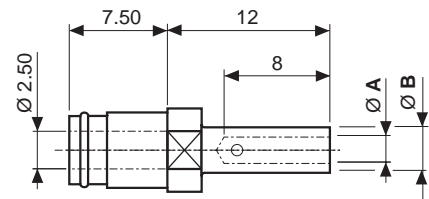

Ref: 025 017 2- 22- G1
Ref: 025 020 2- 23- G1

Ø 3.50 CONTACTS

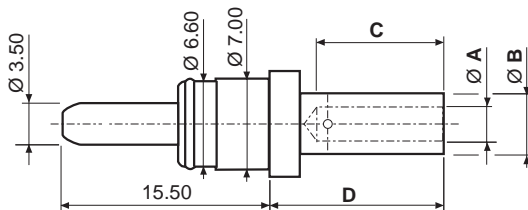

Ref: 035 011 1- 24- OG
Ref: 035 012 1- 25- OG
Ref: 035 013 1- 26- OG
Ref: 035 025 1- 23- OG

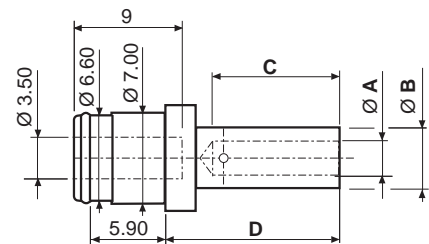

Ref: 035 011 2- 24- G1
Ref: 035 012 2- 25- G1
Ref: 035 013 2- 26- G1
Ref: 035 030 2- 23- G1

Reference	Ø A	Ø B	C	D	AWG*
Ø 2.50					
025 018 1- 22- OG 025 017 2- 22- G1	1.95	3.10	-	-	16-14
025 020 1- 23- OG 025 020 2- 23- G1	1.50	3.10	-	-	22-20-18-16
Ø 3.50					
035 011 1- 24- OG 035 011 2- 24- G1	2.10	4.10	8	12	14-13
035 012 1- 25- OG 035 012 2- 25- G1	1.95	3.10	8	12	16-14
035 013 1- 26- OG 035 013 2- 26- G1	1.50	3.10	8	12	22-17
035 025 1- 23- OG 035 030 2- 23- G1	4.55	5.65	9.50	14	8

CONTACTS

MALE

FEMALE

Ø 1.50 CONTACTS - WIRE WRAP TERMINATION

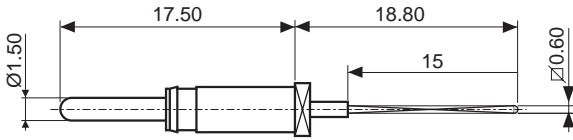

Ref: 015 113 1- 51- OG

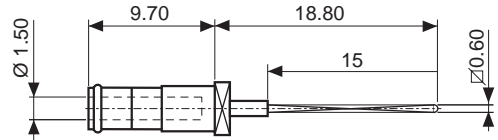

Ref: 015 113 2- 51- G1

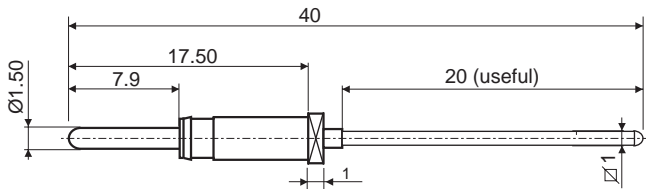

Ref: 015 115 1- 56- OG

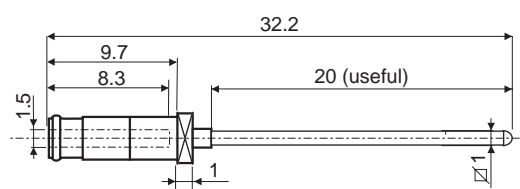

Ref: 015 115 2- 56- G1

Ø 1.50 CONTACTS - POST TERMINATION

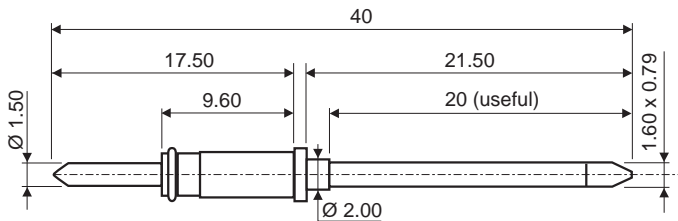

Ref: 015 086 1- 62- OG

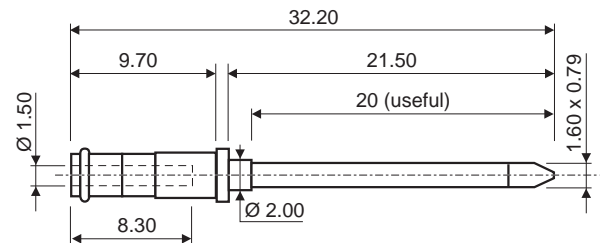

Ref: 015 086 2- 62- G1

COAXIAL CONTACTS

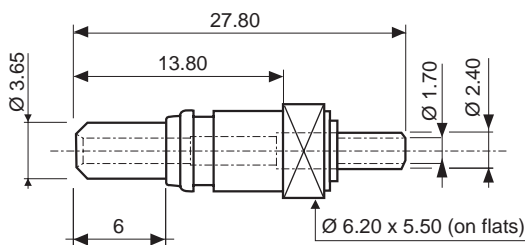

Ref: 037 003 1- XB- U1

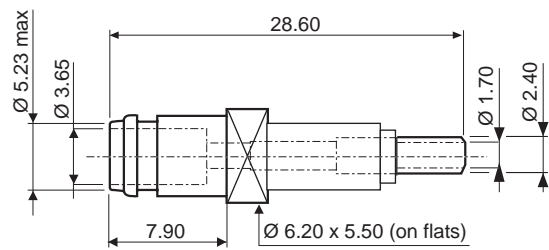

Ref: 037 003 2- XB- U1

TECHNICAL CHARACTERISTICS

Impedance	cable KX22A (RG316): 50 Ω	cable RG179B/U: 75 Ω
Current rating	3 A	
Contact resistance	Internal ≤ 10 mΩ	External ≤ 0.8 mΩ
Insulation resistance	> 5.10 ³ MΩ (500VDC)	
Temperature range	-40° C +100° C	
Contact life cycle	> 5000	
Standing wave ratio up to	1.2 (500 MHz)	

► MODULES

5 X Ø 1.50

L/RH

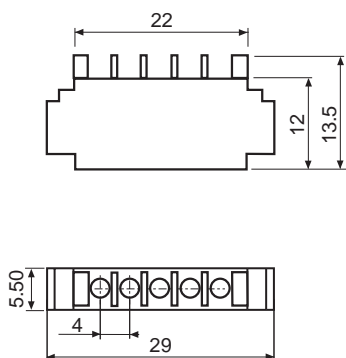

Ref: L-- 515 00 00 RHA

L/ZH

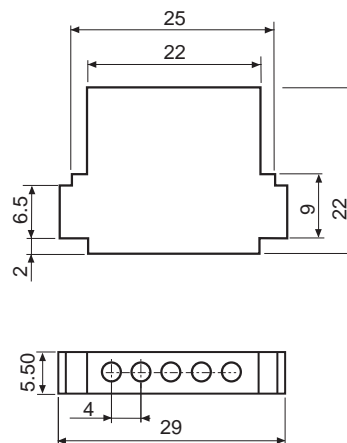

Ref: L -- 515 00 00 ZHA

3 X Ø 2.50

L/SH

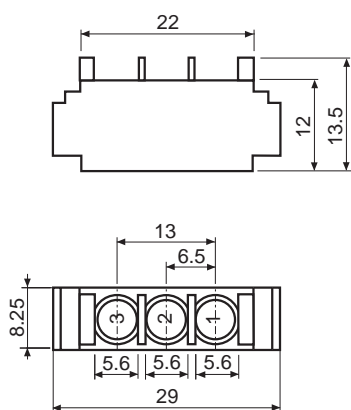

Ref: L-- 325 00 00 SH

2 X Ø 3.50

L/UH

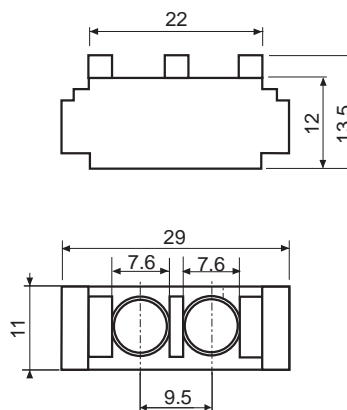

Ref: L-- 235 00 00 UH

MODULES

MODULES EQUIPPED WITH CONTACTS FOR KX15 COAX CABLE

LVM

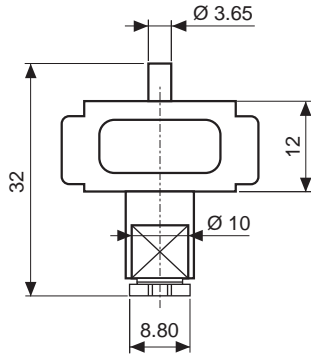

Solder termination Ref: L-- 1CX 11 40 VM
Crimp termination Ref: L-- 1CX 11 20 VPM

LVF

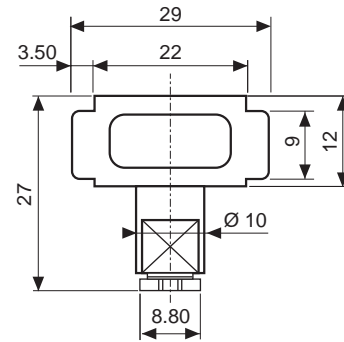

Solder termination Ref: L -- 1CX 20 40 VF
Crimp termination Ref: L -- 1CX 20 20 VPF

TECHNICAL CHARACTERISTICS		
Impedence	50 Ω	
Current rating	2 A	
Contact resistance	Internal ≤ 10 m Ω	External ≤ 1 m Ω
Insulation resistance	$> 5 \cdot 10^3$ M Ω (500VDC)	
Dielectric withstanding voltage	Internal 1000 Vrms	External 4800 Vrms
Temperature range	-40° C +100° C	
Module pitches number	4 as 22 mm	
Recommended cable	KX15	

Note: LVM and LVF modules can also accept KX4, K13, RG13, RG14 coax cable

► LAYOUTS IN COMPLIANCE WITH NF 61-032

Ø 1.50 CONTACTS WITH L/RH MODULES

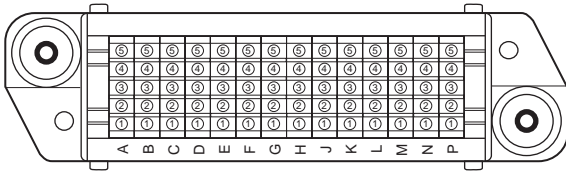

Ref: 02/102 14 modules L/RH*

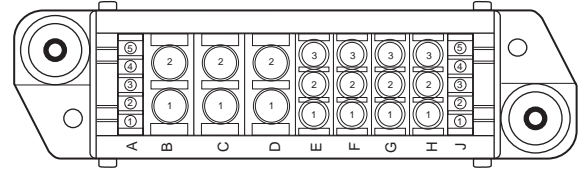

Ref: 20/120 11 modules L/RH
2 modules L/SH*

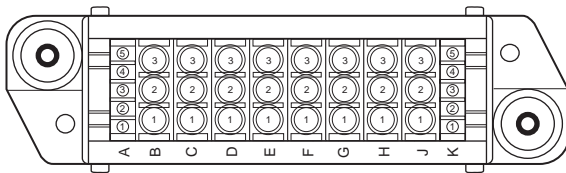

Ref: 04/104 2 modules L/RH
4 modules L/SH
3 modules L/UH*

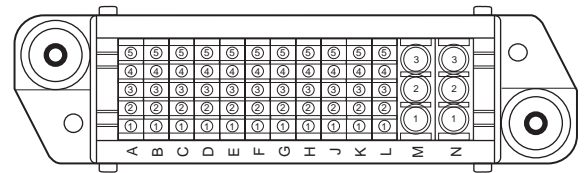

Ref: 30/130 6 modules L/RH
4 modules L/SH
1 modules L/UH*

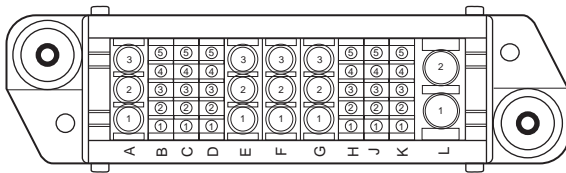

Ref: 08/108 2 modules L/RH
8 modules L/SH*

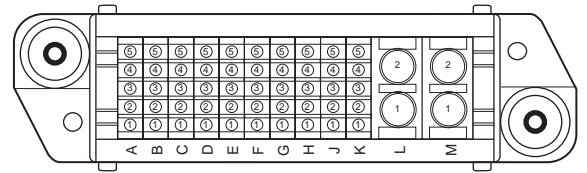

Ref: 47/147 10 modules L/RH
2 modules L/UH*

Ø 1.50 CONTACTS WITH L/ZH MODULES

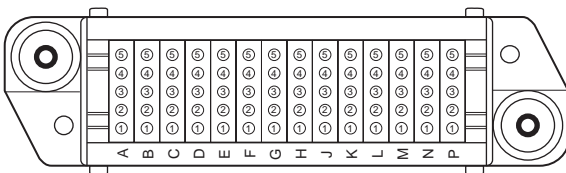

Ref: 202/302 14 modules L/ZH

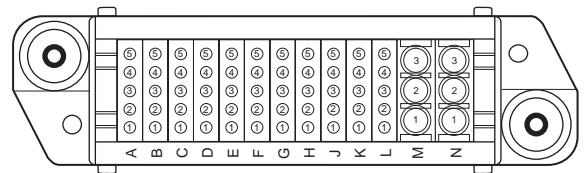

Ref: 220/320 11 modules L/ZH
12 modules L/SH

OTHER LAYOUTS

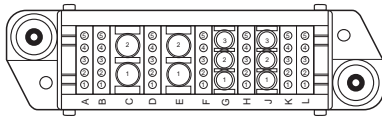

Ref: 201/301 7 modules L/ZH
2 modules L/SH
2 modules L/UH

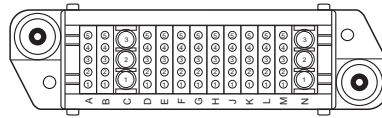

Ref: 209/309 11 modules L/ZH
12 modules L/SH

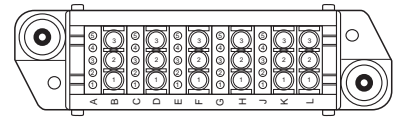

Ref: 217/317 5 modules L/ZH
6 modules L/SH

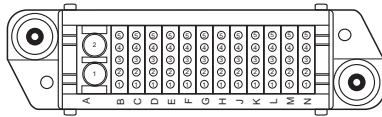

Ref: 203/303 12 modules L/ZH
11 modules L/UH

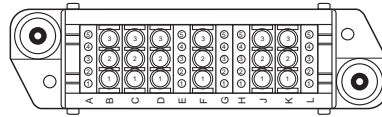

Ref: 210/310 5 modules L/ZH
6 modules L/SH

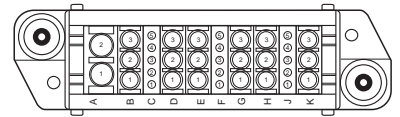

Ref: 219/319 3 modules L/ZH
6 modules L/SH
1 module L/UH

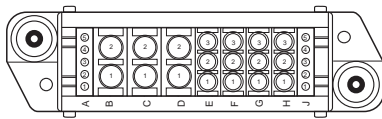

Ref: 204/304 2 modules L/ZH
4 modules L/SH
3 modules L/UH

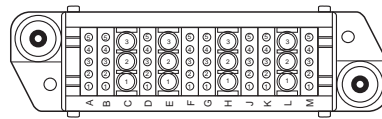

Ref: 211/311 8 modules L/ZH
4 modules L/SH

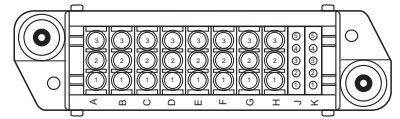

Ref: 222/322 2 modules L/ZH
8 modules L/SH

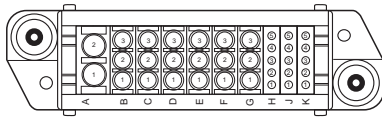

Ref: 205/305 3 modules L/ZH
6 modules L/SH
1 module L/UH

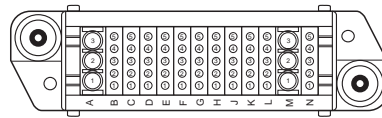

Ref: 212/312 11 modules L/ZH
12 modules L/SH

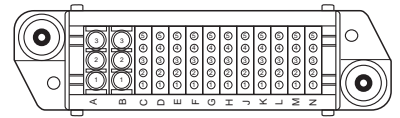

Ref: 223/323 11 modules L/ZH
12 modules L/SH

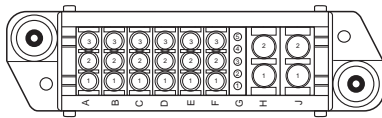

Ref: 206/306 1 modules L/ZH
6 modules L/SH
2 modules L/UH

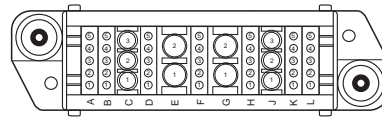

Ref: 213/313 7 modules L/ZH
2 modules L/SH
2 modules L/UH

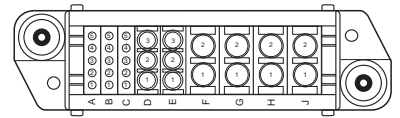

Ref: 224/324 3 modules L/ZH
2 modules L/SH
4 modules L/UH

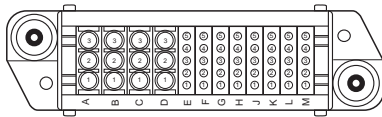

Ref: 207/307 8 modules L/ZH
4 modules L/SH

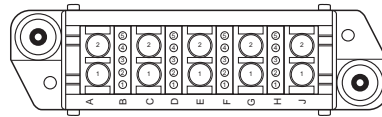

Ref: 215/315 4 modules L/ZH
5 modules L/UH

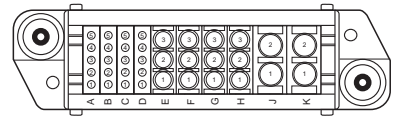

Ref: 225/325 4 modules L/ZH
4 modules L/SH
2 modules L/UH

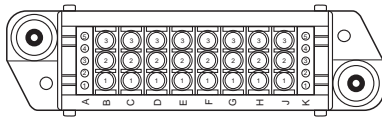

Ref: 208/308 2 modules L/ZH
8 modules L/SH

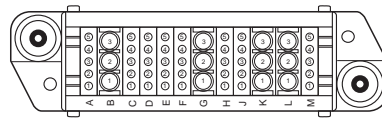

Ref: 216/316 8 modules L/ZH
4 modules L/SH

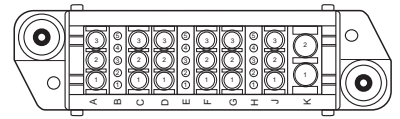

Ref: 226/326 3 modules L/ZH
4 modules L/SH
1 module L/UH

Note: only receptacle layouts are represented termination side view

▶ OTHER LAYOUTS

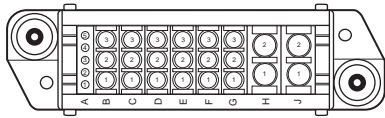

Ref: 227/327 1 module L/ZH
6 modules L/SH
2 modules L/UH

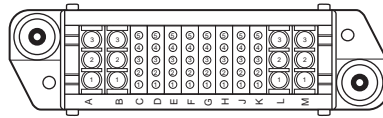

Ref: 235/335 8 modules L/ZH
4 modules L/SH

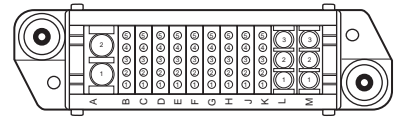

Ref: 242/342 9 modules L/ZH
2 modules L/SH
1 module L/UH

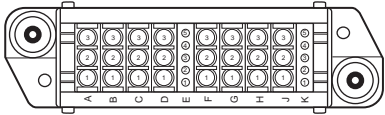

Ref: 229/329 2 modules L/ZH
8 modules L/SH

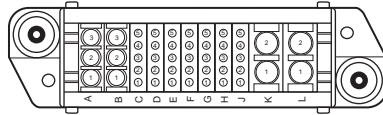

Ref: 236/336 7 modules L/ZH
2 modules L/SH
2 modules L/UH

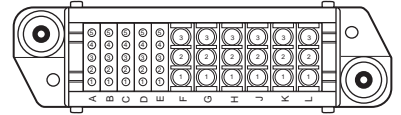

Ref: 243/343 5 modules L/ZH
6 modules L/SH

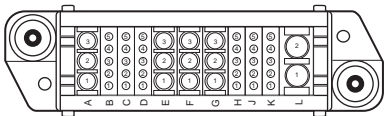

Ref: 230/330 6 modules L/ZH
4 modules L/SH
1 module L/UH

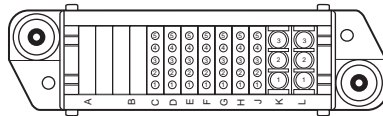

Ref: 237/337 7 modules L/ZH
2 modules L/SH
2 modules L/UH

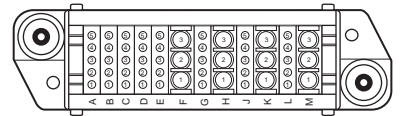

Ref: 245/345 8 modules L/ZH
4 modules L/SH

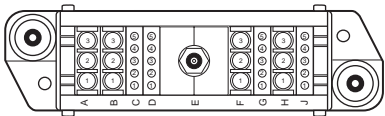

Ref: 231/331 4 modules L/ZH
4 modules L/SH
1 module L/V-

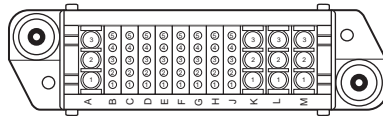

Ref: 238/338 8 modules L/ZH
4 modules L/SH

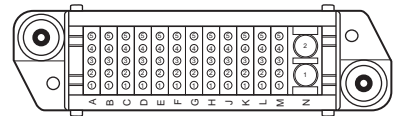

Ref: 246/346 12 modules L/ZH
11 modules L/UH

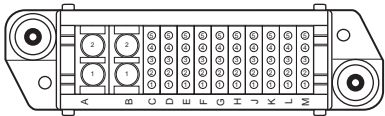

Ref: 232/332 10 modules L/ZH
2 modules L/UH

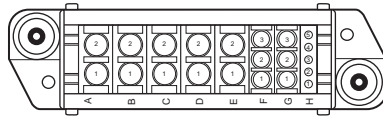

Ref: 239/339 1 module L/ZH
2 modules L/SH
5 modules L/UH

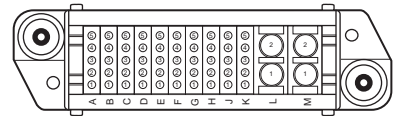

Ref: 247/347 10 modules L/ZH
12 modules L/UH

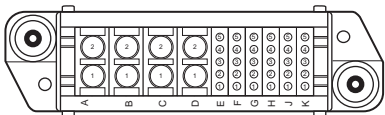

Ref: 233/333 6 modules L/ZH
4 modules L/UH

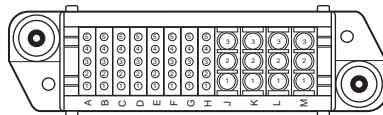

Ref: 240/340 8 modules L/ZH
4 modules L/SH

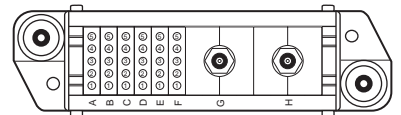

Ref: 250/350 6 modules L/ZH
2 modules L/V-

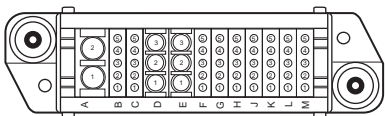

Ref: 234/334 9 modules L/ZH
2 modules L/SH
1 module L/UH

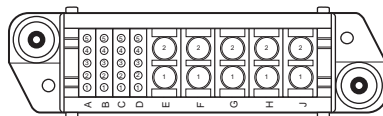

Ref: 241/341 4 modules L/ZH
5 modules L/SH

Note: only receptacle layouts are represented termination side view.
Contact us for specific contact layouts

▶ PANEL CUT OUT

RECEPTACLE PANEL CUT OUT

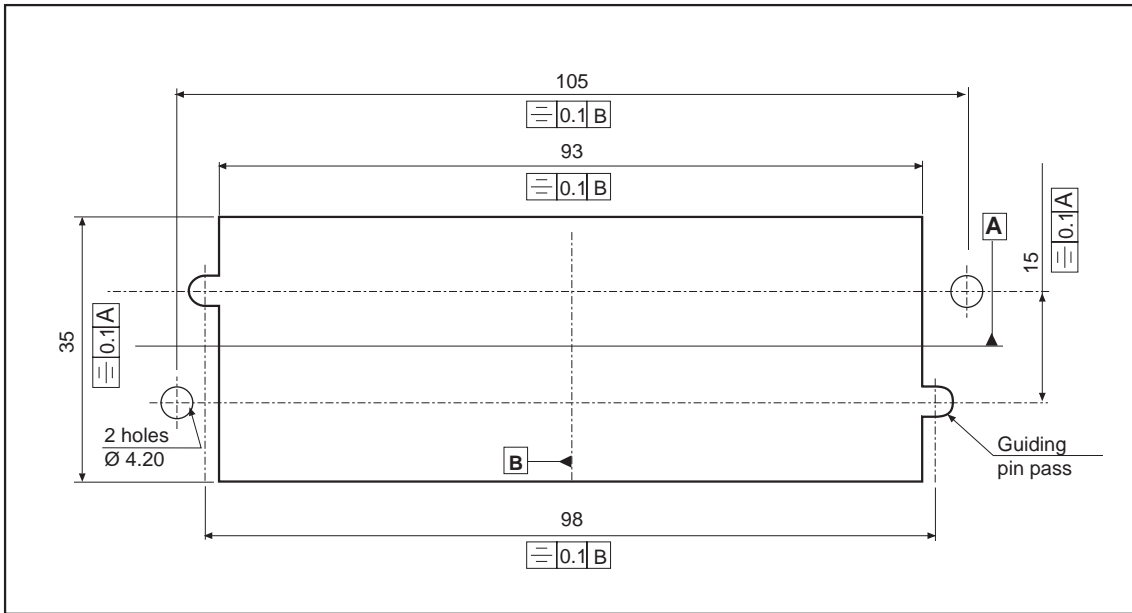

PLUG PANEL CUT OUT

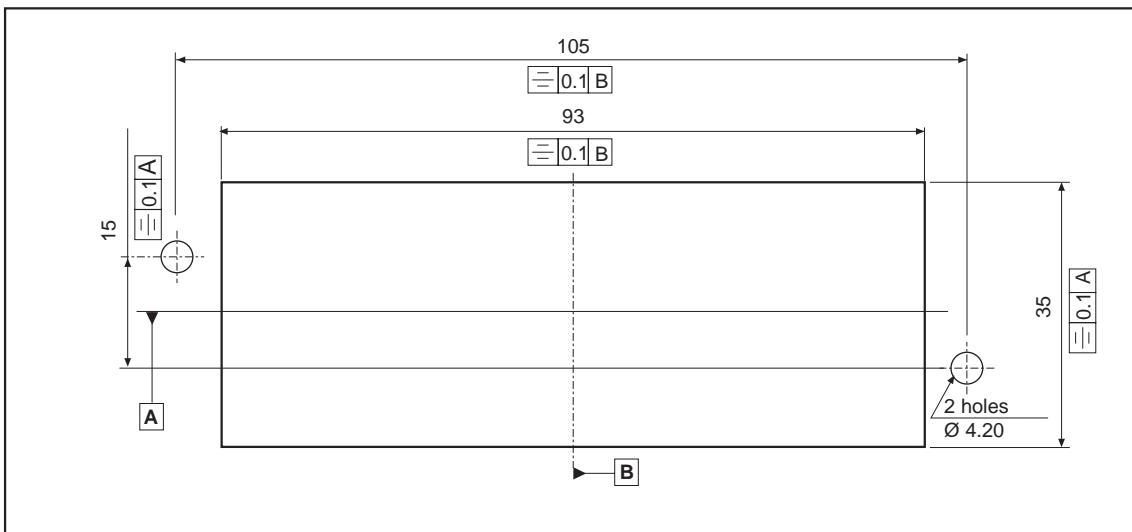

► TOOLS

CRIMPING

Contact Part number	Crimp tool	AWG	Wire cross section	Positioner	Tool turret	Selector position				
015 068 2- 20- G1 015 076 1- 20- OG	ASTRO TOOL TGV 101	24	0.22		ASTRO TOOL TGV 202 red	2				
		22	0.34			3				
		20	0.60			4				
		18	0.93			5				
		16	1.34			6				
		14	1.91			7				
		DANIELS FT8	24			0.22	2			
	22		0.34	3						
	20		0.60	4						
	18		0.93	5						
	16		1.34	6						
	14		1.91	7						
	025 018 1- 22- OG 025 017 2- 22- G1		ASTRO TOOL TGV 101	16	1.34		ASTRO TOOL TGV 202 blue	6		
		15		1.50	6					
15		1.82		7						
14		1.91		7						
14		2.00		7						
DANIELS FT8		16		1.34	6					
		15		1.50	6					
		15	1.82	7						
		14	1.91	7						
		14	2.00	7						
		025 020 1- 23- OG 025 020 2- 23- G1	ASTRO TOOL TGV 101	22	0.34		ASTRO TOOL TGV 202 blue	5		
				20	0.60			6		
18				0.93	6					
18				1.00	6					
16	1.34			6						
DANIELS FT8	22			0.34	5					
	20			0.60	6					
	18		0.93	6						
	18		1.00	6						
	16		1.34	6						
	035 011 1- 24- OG 035 011 2- 24- G1		DANIELS M317	14	1.91		DANIELS TP 805	3		
				14	2.00			3		
13				2.50	4					
ASTRO TOOL TGV 515			14	1.91	Without	ASTRO TOOL TGV 503	3			
		14	2.00	3						
		13	2.50	4						
		035 012 1- 25- OG 035 012 2- 25- G1	DANIELS M317	16			1.34		DANIELS TP 805	2
				15			1.50			2
14	1.91			3						
14	2.00			3						
ASTRO TOOL TGV 515	16		1.34	Without	ASTRO TOOL TGV 503	2				
	15		1.50			2				
	14		1.91			3				
	14		2.00			3				
035 013 1- 26- OG 035 013 2- 26- G1	DANIELS M317	22	0.38		DANIELS TP 805	1				
		20	0.60			1				
		18	0.93			2				
		18	1.00			2				
		ASTRO TOOL TGV 515	22			0.38	Without	ASTRO TOOL TGV 503	1	
	20		0.60	1						
	18		0.93	2						
	18		1.00	2						
	035 025 1- 23- OG 035 030 2- 23- G1		DANIELS M300 BT	8	8.98				M22520/1,05	4

▶ TOOLS

INSERTION AND EXTRACTION

	Males	Females		
Contact Ø	Part number	Part number	Insertion tool	Extracting tool
1.50	0150 761-20-OG	0150 682-20-G1	S_059 ⁽¹⁾	S__051 S__072 S__083
			S_051	
			SM-0150000002 ⁽²⁾	
			SM-0150000003 ⁽³⁾	
			SME-0150000000 ⁽⁴⁾	
2.50	0250 181-22-OG	0250 172-22-G1	SE-0250000001	S__078
	0250 201-23-OG	0250 202-23-G1		S__083
3.50	0350 111-24-OG	0350 112-24-G1	SE-0350000001	S__083 ⁽⁵⁾
	0350 121-25-OG	0350 122-25-G1		
	0350 131-26-OG	0350 132-26-G1		
	0350 251-23-OG	0350 302-23-G1		

(1) straight tool

(2) unwedge tool

(3) bent tool

(4) Straight, unwedge and bent tools kit

(5) tool for Ø 1.50, 2.50 and 3.50 contacts

► **SPECIFIC ARRANGEMENT WITH HIGH SPEED QUADRAX CONTACTS**

TECHNICAL CHARACTERISTICS

ELECTRICAL	
Current rating	7.5 A
Contact resistance	< 3.5 mΩ
Withstanding voltage	2000 V

MECHANICAL	
Contact rotation	70daN.cm
Contact retention	>250N
Contact pull	>250N
Mating cycles	>500 cycles

ENVIRONMENTAL	
Dry heat	1000H at 125°C (standard value: 96H)
Temperature range	-55°C at +125°C, 5 cycles
Salt spray	96H (5% NaCl)
Damped heat	56 days (40°C 90/95% HR)
Fire and Smoke	According to NF F 16-101, NF F 16-102

- Technology designed especially for the transmission of Ethernet high-speed signals required in harsh environment railway applications.
- Design combining the benefits of the hyperboloid technology with a ruggedised shell housing.
- Modular design: Twinax, Triax and Quadrax versions
- Performances meeting the evolutions of the railway industry requirements: signal frequencies higher (1.2 GHz) than the existing standard contact on the market
- Ruggedised connector: 1 million balancing cycles testing
- Easy cabling mounting: cabling process designed with R&D teams of the main rolling stock manufacturers. Cables used: 100, 120 or 150 Ω
- Shock and vibration proofed: use of the 1.02mm hyperboloid socket contact
- Male and female modules are interchangeable
- Design for use of standard existing tools: crimp tool and positioner



► SPECIFIC ARRANGEMENT WITH HIGH SPEED QUADRAX CONTACTS

MOUNTING EXAMPLE WITH B/HD

MALE

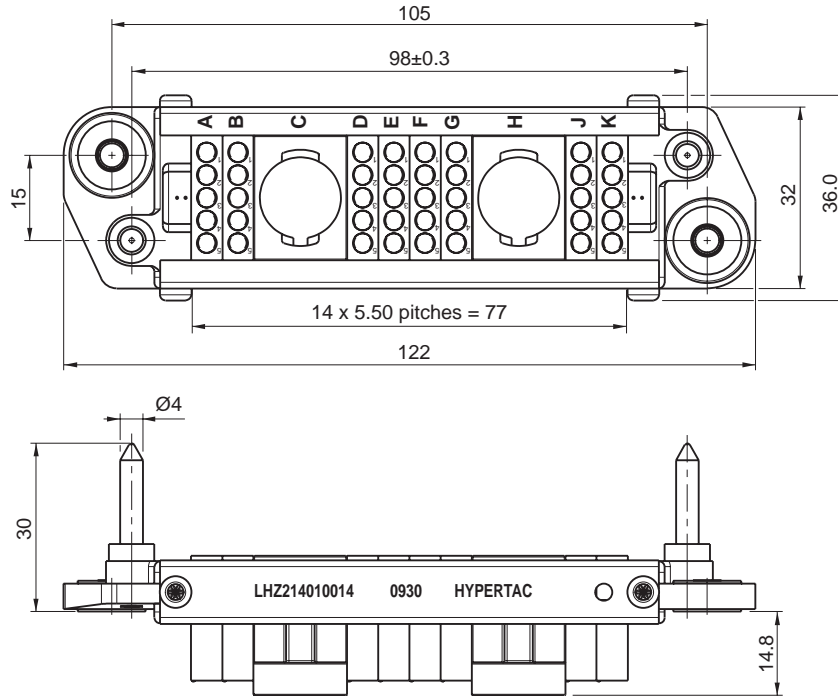

FEMALE

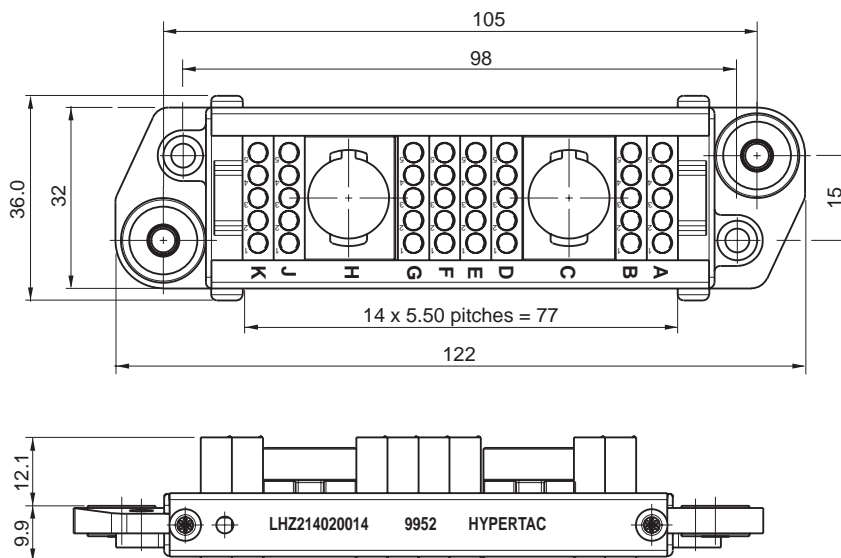

► SPECIFIC ARRANGEMENT WITH HIGH SPEED QUADRAX CONTACTS

CONTACTS

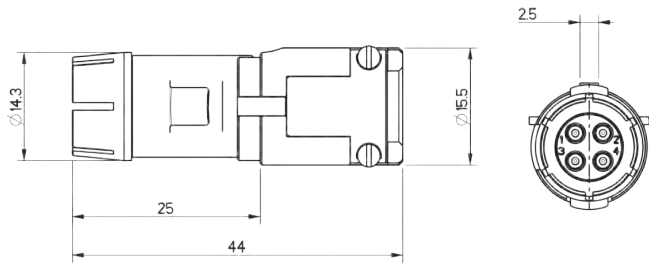

Male - Ref: 123 012 1- QAR 01

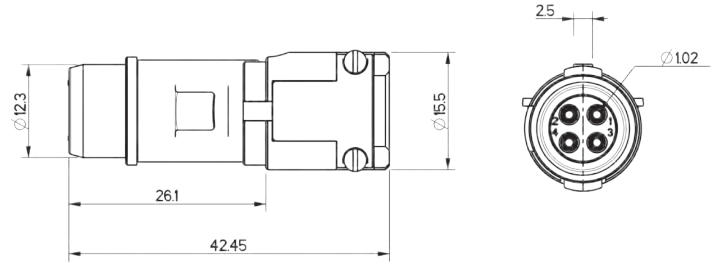

Female - Ref: 123 012 2- QAR 01

MODULES

PLUG

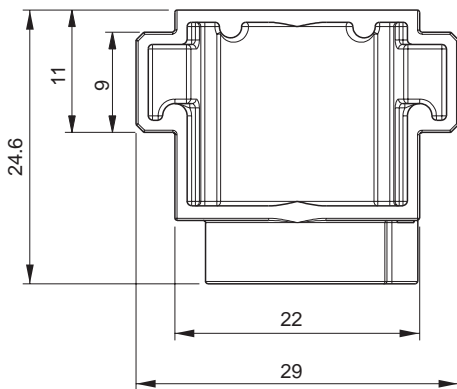

RECEPTACLE

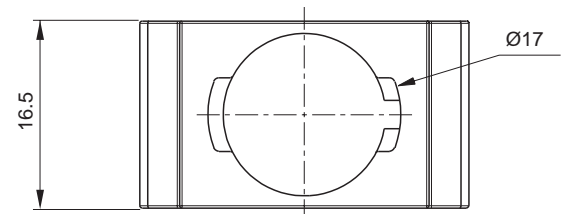
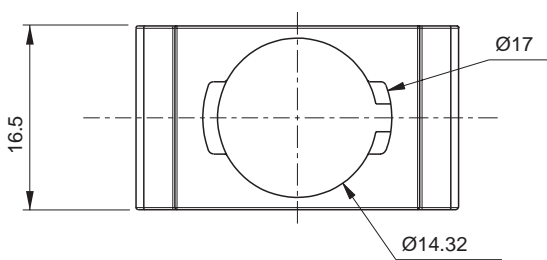
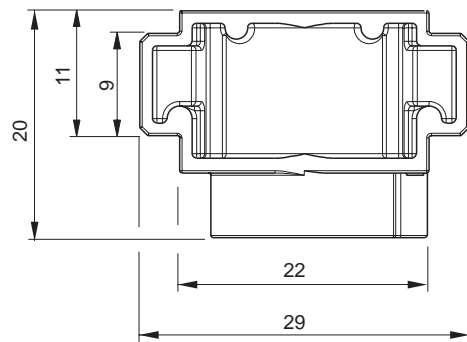

Note: For other configurations, please contact us

► **SPECIFIC ARRANGEMENT WITH HIGH SPEED QUADRAX CONTACTS**

TOOLS

Contacts		Crimping Tool			Tools	
Arrangement	Part Number	Crimping Tool	Tool turret	Position & Wire Section	Insertion	Extraction
P01 & A01	123 012 1- QAR 01	Astro-tool TGV 101	TGV 210	S.055	S.132	
		Daniels FT8	TP 945			
P02	123 012 2- QAR 01	Astro-tool TGV 101	TGV 210			
		Daniels FT8	TP 945			

SMITHS CONNECTORS PRODUCT LINES

PCB

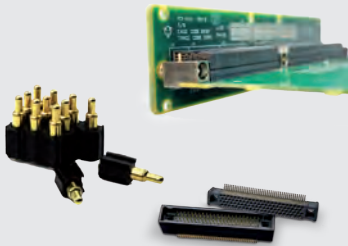

- ▶ Low, medium and high density board-to-board, cable to board and stacking
- ▶ Rugged standard
- ▶ Low profile
- ▶ Signal, power, coaxial & high speed configurations
- ▶ Self configurable board-to-board
- ▶ Spring probe connectors
- ▶ Mixed signal, power and coaxial contact connectors
- ▶ Different termination styles: solder cup, crimp, SMT and SMT flex, press fit, solder dip.

POWER



- ▶ Circular
- ▶ Configurable rectangular
- ▶ Ruggedized
- ▶ Single and Multi-Way Connectors
- ▶ Power contact up to 1,200 Amps
- ▶ Excellent performance in harsh environment conditions
- ▶ Cable assembling

EMI/EMP FILTER

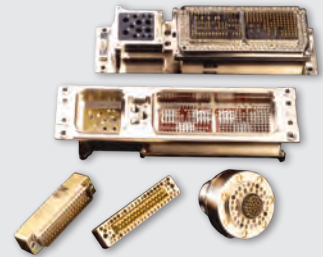

- ▶ EMI/RFI filtering and transient protection
- ▶ RoHS compliant solderless filter connectors available
- ▶ Circular, ARINC, D-Subminiature Micro-D
- ▶ Filtered adapters for "bolt on" EMI /EMP solutions
- ▶ Filter hybrid capability

MODULAR/RECTANGULAR



- ▶ Configurable with modules for signal, power, coax, fiber optics and/or pneumatics
- ▶ Easy configuration in a single frame
- ▶ For rack & panel, and cable applications
- ▶ Guided hardware for blind
- ▶ D-sub connectors
- ▶ Micro-D style
- ▶ Signal connectors for hand held and docking stations

CIRCULAR



- ▶ Metal and Plastic
- ▶ Industrial M12, M23, M40, M58
- ▶ Crimp and solder terminations
- ▶ Various types of cable clamps
- ▶ Push Pull/ latch mechanism
- ▶ Color coding

HEAVY DUTY



- ▶ Ultra reliable hyperboloid contact
- ▶ Modular solution: signal, power, data contacts, and fiber optics
- ▶ High resistance in harsh environment
- ▶ EMC shielding
- ▶ Easy cable mounting
- ▶ High pressure up to 35K PSI, 250° C
- ▶ High temperature up to 440° C

SPRING PROBES

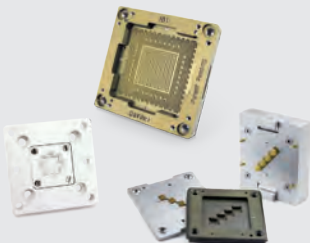

- ▶ Z-axis compliant
- ▶ Blind mate engagement
- ▶ Long cycle life
- ▶ High density
- ▶ Extreme miniaturization
- ▶ Printed circuit board test
- ▶ Bare board test
- ▶ Coaxial contacts

MIL/AERO STANDARD



- ▶ Standard military interface
- ▶ ARINC interface
- ▶ ARINC 801
- ▶ Custom inserts

HIGH SPEED COPPER/FIBER

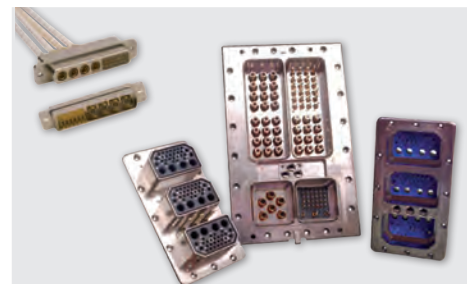

- ▶ Quadrx and Twinax Connectors
- ▶ Rugged D-Sub Connectors
- ▶ ARINC and MIL-STD Contacts
- ▶ Micro Twinax/Quadrx
- ▶ Butt-Joint and Expanded Beam Contacts
- ▶ ARINC 801 Termini
- ▶ Floating Fiber Termini



SMITHS CONNECTORS GLOBAL SUPPORT

AMERICAS

info.us@smithsconnectors.com

Costa Mesa, CA
1.714.371.1100

Hudson, MA
1.978.568.0451

Kansas City, KS
1.913.342.5544

EUROPE

France

33.2.32969176
info.fr@smithsconnectors.com

Germany

49.991.250.120
info.de@smithsconnectors.com

Italy

39.010.60361
info.it@smithsconnectors.com

United Kingdom

44.208.236.2400
info.uk@smithsconnectors.com

ASIA

asiainfo@smithsconnectors.com

Shanghai, China
86.21.3318.4650

Suzhou, China
86.512.6273.1188

Singapore
65.6846.1655

visit us at | smithsconnectors.com |     